

# NF-TAG-F6-R0-001 Specification

## 1. Applications:

Near Filed Communication (NFC)、RFID

## 2. Explanation of Part Number:

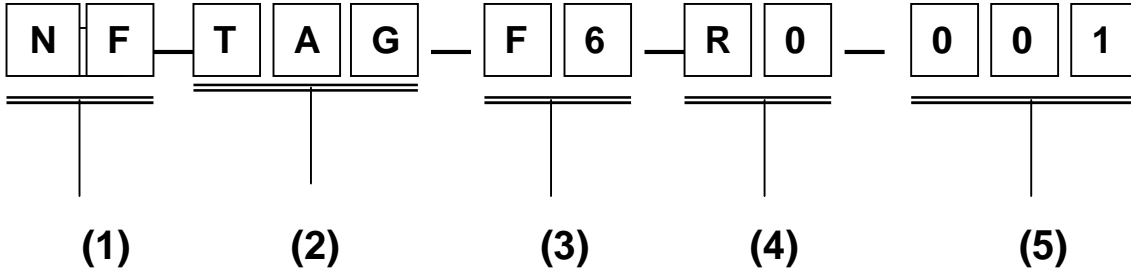

- (1) Product type: NF-Near Field Communication
- (2) Material:Al etching TAG+ NTAG213
- (3) Substrate: F6- Ferrite
- (4) Frequency: R0-13.56MHz (RFID, HF Band)
- (5) Suffix : 001

## 3. Electrical properties:

Frequency Range : 12.5MHZ~15.5MHz ;

Communication baud rate : 106K ;

## 4. Dimensions:

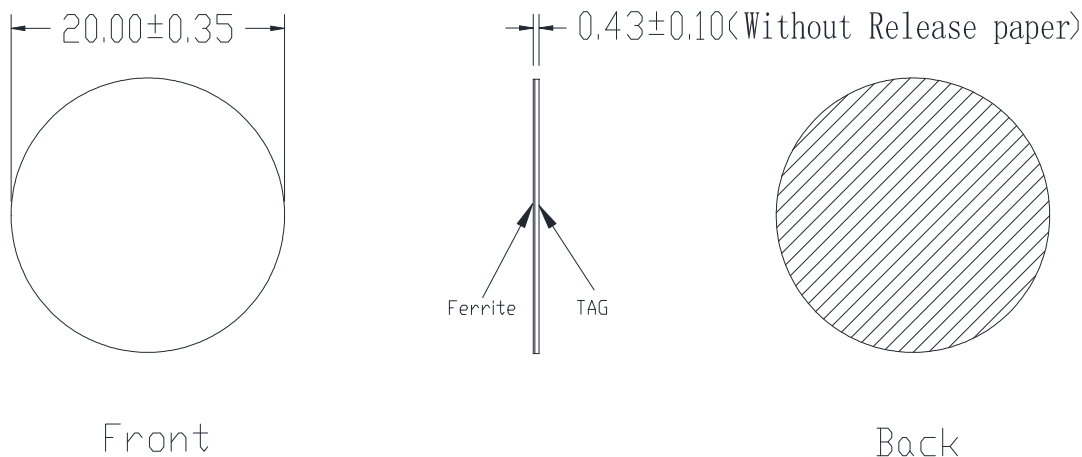

UNLESS OTHER SPECIFIED TOLERANCES ON :		 <b>INPAQ TECHNOLOGY CO., LTD.</b>
X=±	X.X=±	
ANGLES=±	HOLEDIA=±	THIS DRAWINGS AND SPECIFICATIONS ARE THE PROPERTY OF INPAQ TECHNOLOGY CO.,LTD.AND SHALL NOT BE REPRODUCED OR USED AS THE BASIS FOR THE MANUFACTURE OR SALE OF APPARATUS OR DEVICES WITHOUT PERMISSION
SCALE :	UNIT : mm	
DRAWN BY: 李美娟 <i>李美娟</i>	CHECKED BY: 李志强 <i>李志强</i>	
DESIGNED BY: 李美娟 <i>李美娟</i>	APPROVED BY: 唐龙 <i>唐龙</i>	
TITLE : NF-TAG-F6-R0-001Specification		DOCUMENT NO. <b>ENS000087700</b>
		PAGE REV. <b>A0</b>

**Front**

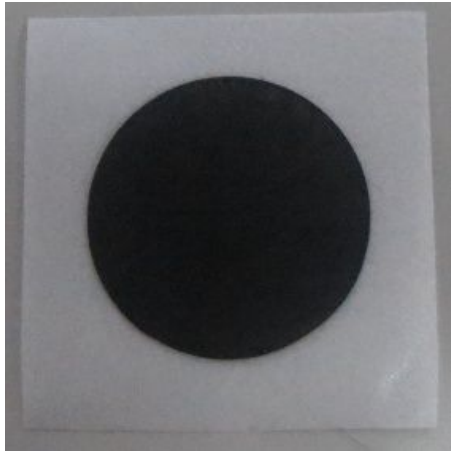

**Back**

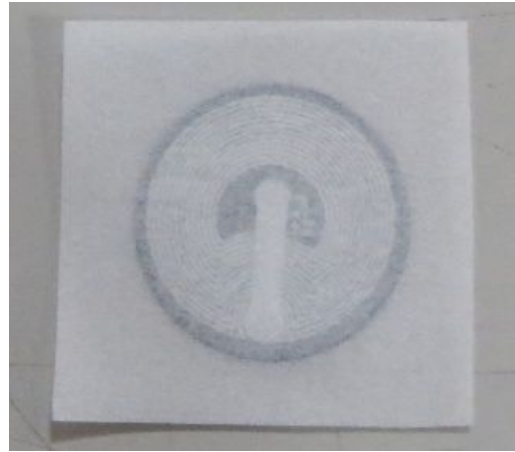

**The product structure**

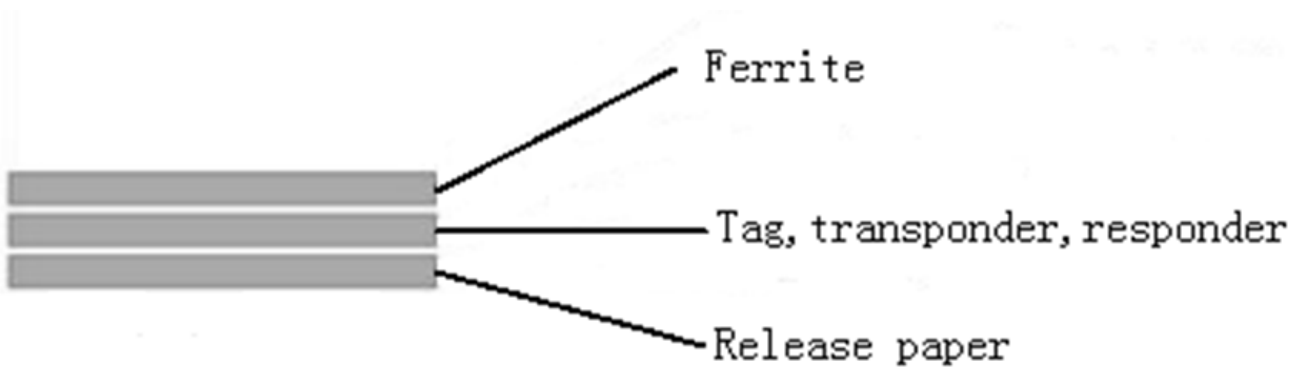

**5. Environmental Specification:**

Working temperature: -20°C~+60°C

Working humidity:10%~95%

Storage temperature:-20°C~+60°C

**6. Packing:**

- 1、 1\*30PCS/PE bag;
- 2、 85 PE bag/Inner Box (1\*30\*85=2550PCS/ Inner Box)
- 3、 4 Inner Box /Master Box (1\*30\*85\*4=10200PCS/ Master Box)

UNLESS OTHER SPECIFIED TOLERANCES ON :		 <b>INPAQ TECHNOLOGY CO., LTD.</b>
X=±	X.X=±	
ANGLES=±	HOLEDIA=±	THIS DRAWINGS AND SPECIFICATIONS ARE THE PROPERTY OF INPAQ TECHNOLOGY CO.,LTD.AND SHALL NOT BE REPRODUCED OR USED AS THE BASIS FOR THE MANUFACTURE OR SALE OF APPARATUS OR DEVICES WITHOUT PERMISSION
SCALE :	UNIT : mm	
DRAWN BY: 李美娟 <i>李美娟</i>	CHECKED BY: 李志强 <i>李志强</i>	
DESIGNED BY: 李美娟 <i>李美娟</i>	APPROVED BY: 唐龙 <i>唐龙</i>	
TITLE : NF-TAG-F6-R0-001Specification		DOCUMENT NO. <b>ENS000087700</b>
		PAGE REV. <b>A0</b>